

Data Sheet



Article number: 021500700105

Description: Sealing Clamp S 105 W5

Measures

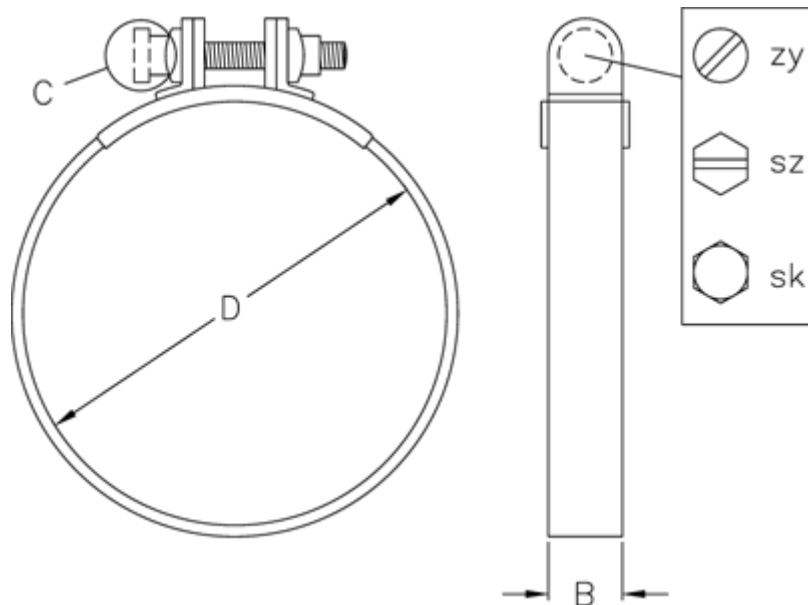

C (screw type)	= SZ
Diameter D	= 105
Width B	= 20